

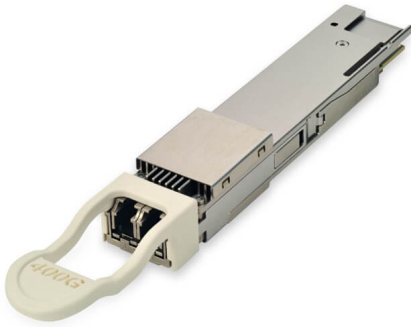

CL-QDD-FR4-2
400G QSFP DD Optical Transceiver Module
RoHS 6 compliant

Features



- QSFP-DD MSA compliant
- 4 CWDM lanes MUX/DEMUX design
- 100G Lambda MSA 400G-FR4 Specification compliant
- Up to 2km transmission on single mode fiber (SMF) with FEC
- Operating case temperature: 0 to +70°C
- 8x53.125Gb/s electrical interface (400GAUI-8)
- Data Rate 106.25Gbps (PAM4) per channel.
- Maximum power consumption 12W
- Duplex LC connector
- RoHS compliant

Applications

- Data Center Interconnect
- 400G Ethernet
- Infiniband interconnects
- Enterprise networking

PART NUMBER	Monitor	INPUT/OUTPUT	SIGNAL DETECT	TEMPERATURE
CL-QDD-FR4-2	X	AC/AC	TTL	-5°C to 70 °C
CL-QDD-FR4-2i	X	AC/AC	TTL	-40°C to 85 °C



CL-QDD-FR4-2
400G QSFP DD Optical Transceiver Module
RoHS 6 compliant

PRODUCT DESCRIPTION

This product is a 400Gb/s Quad Small Form Factor Pluggable-double density (QSFP-DD) optical module designed for 2km optical communication applications. The module converts 8 channels of 50Gb/s (PAM4) electrical input data to 4 channels of CWDM optical signals, and multiplexes them into a single channel for 400Gb/s optical transmission. Reversely, on the receiver side, the module optically de-multiplexes a 400Gb/s optical input into 4 channels of CWDM optical signals, and converts them to 8 channels of 50Gb/s (PAM4) electrical output data.

The central wavelengths of the 4 CWDM channels are 1271, 1291, 1311 and 1331 nm as members of the CWDM wavelength grid defined in ITU-T G.694.2. It contains a duplex LC connector for the optical interface and a 76-pin connector for the electrical interface. To minimize the optical dispersion in the long-haul system, single-mode fiber (SMF) has to be applied in this module. Host FEC is required to support up to 2km fiber transmission

The product is designed with form factor, optical/electrical connection and digital diagnostic interface according to the QSFP-DD Multi-Source Agreement (MSA) Type 2. It has been designed to meet the harshest external operating conditions including temperature, humidity and EMI interference.

Functional Description

The module incorporates 4 independent channels on CWDM4 1271/1291/1311/1331nm center wavelength, operating at 100G per channel. The transmitter path incorporates a quad channel EML driver and EML lasers together with an optical multiplexer. On the receiver path, an optical de-multiplexer is coupled to a 4 channel photodiode array. A DSP basis gearbox is used to convert 8 channels of 25GBaud PAM4 signals into 4 channels of 50GBaud PAM4 signals and also an 8-channel retimer and FEC block are integrated in this DSP. The electrical interface is compliant with IEEE 802.3bs and QSFP-DD MSA in the transmitting and receiving directions, and the optical interface is compliant to IEEE 802.3bs with duplex LC connector.

A single +3.3V power supply is required to power up this product. All the power supply pins are internally connected and should be applied concurrently. As per MSA specifications the module offers seven low speed hardware control pins (including the 2-wire serial interface): ModSelL, SCL, SDA, ResetL, InitMode, ModPrsL and IntL.

Module Select (ModSelL) is an input pin. When held low by the host, this product responds to 2-wire serial communication commands. The ModSelL allows the use of this product on a single 2-wire interface bus – individual ModSelL lines must be used.

Serial Clock (SCL) and Serial Data (SDA) are required for the 2-wire serial bus communication interface and enable the host to access the memory map.

The ResetL pin enables a complete reset, returning the settings to their default state, when a low level on the ResetL pin is held for longer than the minimum pulse length. During the execution of a reset the host shall disregard all status bits until it indicates a completion of the reset interrupt. The product indicates this by posting an IntL (Interrupt) signal with the Data_Not_Ready bit negated in the memory map. Note that on power up (including hot insertion) the module should post this completion of reset interrupt without requiring a reset.

Initialize Mode (InitMode) is an input signal. It is pulled up to Vcc in the QSFP-DD module. The InitMode signal allows the host to define whether the QSFP-DD module will initialize under host software control (InitMode asserted High) or module hardware control (InitMode deasserted Low). Under host software control, the module shall remain in Low Power Mode until software enables the transition to High Power Mode, as defined in the QSFP-DD Management Interface Specification. Under hardware control (InitMode de-asserted Low), the module may immediately transition to High Power Mode after the management interface is initialized. The host shall not change the state of this signal while the module is present. In legacy QSFP applications, this signal is named LPMMode. See SFF-8679 for LPMMode signal description.

Module Present (ModPrsL) is a signal local to the host board which, in the absence of a product, is normally pulled up to the host Vcc. When the product is inserted into the connector, it completes the path to ground through a



CL-QDD-FR4-2
400G QSFP DD Optical Transceiver Module
RoHS 6 compliant

resistor on the host board and asserts the signal. ModPrsL then indicates its present by setting ModPrsL to a “Low” state.

Interrupt (IntL) is an output pin. “Low” indicates a possible operational fault or a status critical to the host system. The host identifies the source of the interrupt using the 2-wire serial interface. The IntL pin is an open collector output and must be pulled to the Host Vcc voltage on the Host board.

I. Absolute Maximum Ratings

Parameter	Symbol	Min	Max	Units	Notes
Storage Temperature	T _s	-40	85	degC	
Operating Case Temperature	T _{OP}	0	70	degC	
Power Supply Voltage	V _{CC}	-0.5	3.6	V	
Relative Humidity (non-condensation)	RH	0	85	%	
Damage Threshold, each Lane	TH _d	4.5		dBm	

II. Recommended Operating Conditions

Parameter	Symbol	Min	Typical	Max	Units	Notes
Operating Case Temperature	T _{OP}	0		70	degC	
Power Supply Voltage	V _{CC}	3.135	3.3	3.465	V	
Data Rate, each Lane			26.5625		GBd	PAM4
Data Rate Accuracy		-100		100	ppm	
Pre-FEC Bit Error Ratio				2.4x10 ⁻⁴		
Post-FEC Bit Error Ratio				1x10 ⁻¹²		1
Link Distance	D	0.002		2	km	2

Notes:

1. FEC provided by host system.
2. FEC required on host system to support maximum distance.



CL-QDD-FR4-2
400G QSFP DD Optical Transceiver Module
RoHS 6 compliant

III. Optical Characteristics

Parameter	Symbol	Min	Typical	Max	Units	Notes
Wavelength Assignment	L0	1264.5	1271	1277.5	nm	
	L1	1284.5	1291	1297.5	nm	
	L2	1304.5	1311	1317.5	nm	
	L3	1324.5	1331	1337.5	nm	
Transmitter						
Data Rate, each Lane		53.125 ± 100 ppm			GBd	
Modulation Format			PAM4			
Side-mode Suppression Ratio	SMSR	30			dB	
Total Average Launch Power	P _T			9.3	dBm	
Average Launch Power, each Lane	P _{AVG}	-3.3		3.5	dBm	1
Outer Optical Modulation Amplitude (OMA _{outer}), each Lane	P _{OMA}	-0.3		3.7	dBm	2
Launch Power in OMA _{outer} minus TDECQ, each Lane for ER ≥ 4.5dB for ER < 4.5dB		-1.7 -1.6			dB	
Transmitter and Dispersion Eye Closure for PAM4, each Lane	TDECQ			3.4	dB	
TDECQ – 10*log ₁₀ (C _{eq}), each Lane				3.4	dB	3
Extinction Ratio	ER	3.5			dB	
Difference in Launch Power between any Two Lanes(O MA _{outer})				4	dB	
RIN _{17.1} OMA	RIN			-136	dB/Hz	
Optical Return Loss Tolerance	TOL			17.1	dB	
Transmitter Reflectance	R _T			-26	dB	
Transmitter Transition Time				17	ps	
Average Launch Power of OFF Transmitter, each Lane	P _{off}			-20	dBm	
Receiver						
Data Rate, each Lane		53.125 ± 100 ppm			GBd	
Modulation Format		PAM4				
Damage Threshold, each Lane	TH _d	4.5			dBm	4
Average Receive Power, each Lane		-7.3		3.5	dBm	5
Receive Power (OMA _{outer}), each Lane				3.7	dBm	



CL-QDD-FR4-2
400G QSFP DD Optical Transceiver Module
RoHS 6 compliant

Difference in Receiver Power between any Two Lanes(OMA_{outer})				4.1	dB	
Receiver Sensitivity (OMA_{outer}), each Lane	SEN			Equation (1)	dBm	6
Stressed Receiver Sensitivity (OMA_{outer}), each Lane	SRS			-2.6	dBm	7
Receiver Reflectance	RR			-26	dB	
LOS Assert	LOS A	-20			dBm	
LOS De-assert	LOS D			-10.3	dBm	
LOS Hysteresis	LOS H	0.5			dB	
Stressed Conditions for Stress Receiver Sensitivity (Note 8)						
Stressed Eye Closure for PAM4 (SECQ), Lane under Test				3.4	dB	
SECQ – $10 \cdot \log_{10}(C_{eq})$, Lane under Test				3.4	dB	
OMA_{outer} of each Aggressor Lane				1.5	dBm	

Notes:

1. Average launch power, each lane (min) is informative and not the principal indicator of signal strength. A transmitter with launch power below this value cannot be compliant; however, a value above this does not ensure compliance.
 2. Even if the TDECQ < 1.4 dB for an extinction ratio of ≥ 4.5 dB or TDECQ < 1.3 dB for an extinction ratio of < 4.5 dB, the OMA_{outer} (min) must exceed the minimum value specified here.
 3. C_{eq} is a coefficient defined in IEEE Std 802.3-2018 clause 121.8.5.3 which accounts for reference equalizer noise enhancement.
 4. Average receive power, each lane (min) is informative and not the principal indicator of signal strength. A received power below this value cannot be compliant; however, a value above this does not ensure compliance.
 5. The receiver shall be able to tolerate, without damage, continuous exposure to an optical input signal having this average power level.
 6. Receiver sensitivity (OMA_{outer}) is informative and is defined for a transmitter with a value of SECQ up to 3.4 dB. Receiver sensitivity should meet Equation (1), which is illustrated in Figure 4.
- $RS = \max(-4.6, SECQ - 6.0) dBm$
 Where:
 RS is the receiver sensitivity, and
 SECQ is the SECQ of the transmitter used to measure the receiver sensitivity.
7. Measured with conformance test signal at TP3 for the BER equal to 2.4×10^{-4} .
 8. These test conditions are for measuring stressed receiver sensitivity. They are not characteristics of the receiver.



CL-QDD-FR4-2
400G QSFP DD Optical Transceiver Module
RoHS 6 compliant

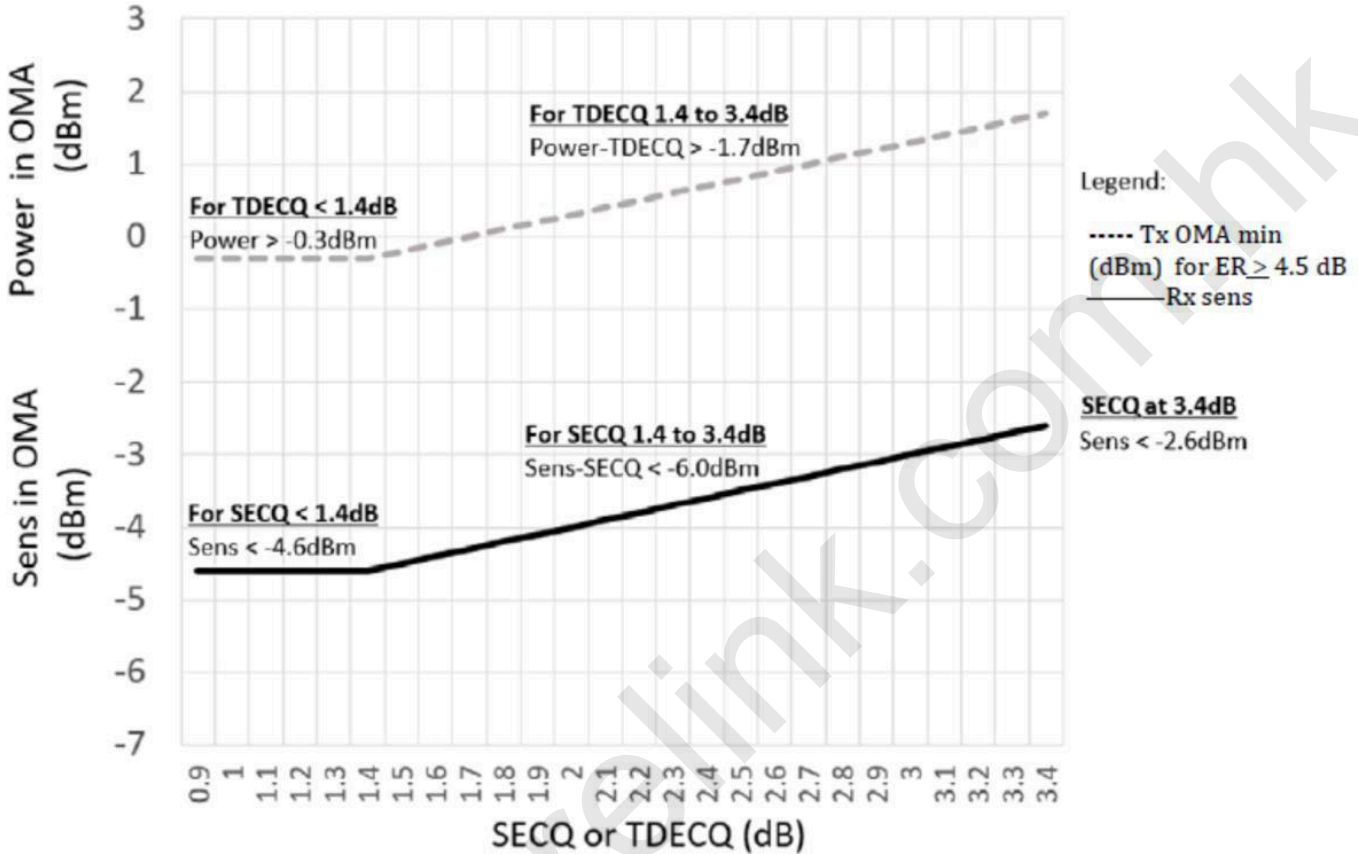

IV. Electrical Characteristics

The following electrical characteristics are defined over the Recommended Operating Environment unless otherwise specified.

Parameter	Test Point	Min	Typical	Max	Units	Notes
Power Consumption				12	W	
Supply Current	I _{cc}			3.64	A	
Transmitter (each Lane)						
Signaling Rate, each Lane	TP1	26.5625 ± 100 ppm			GBd	
Differential pk-pk Input Voltage Tolerance	TP1a	900			mV _{pp}	1
Differential Termination Mismatch	TP1			10	%	
Differential Input Return Loss	TP1	IEEE 802.3-2015 Equation (83E-5)			dB	
Differential to Common Mode Input Return Loss	TP1	IEEE 802.3-2015 Equation (83E-6)			dB	



CL-QDD-FR4-2
400G QSFP DD Optical Transceiver Module
RoHS 6 compliant

Module Stressed Input Test	TP1a	See IEEE 802.3bs 120E.3.4.1				2
Single-ended Voltage Tolerance Range (Min)	TP1a	-0.4 to 3.3			V	
DC Common Mode Input Voltage	TP1	-350		2850	mV	3
Receiver (each Lane)						
Signaling Rate, each lane	TP4	26.5625 ± 100 ppm			GBd	
Differential Peak-to-Peak Output Voltage	TP4			900	mVpp	
AC Common Mode Output Voltage, RMS	TP4			17.5	mV	
Differential Termination Mismatch	TP4			10	%	
Differential Output Return Loss	TP4	IEEE 802.3-2015 Equation (83E-2)				
Common to Differential Mode Conversion Return Loss	TP4	IEEE 802.3-2015 Equation (83E-3)				
Transition Time, 20% to 80%	TP4	9.5			ps	
Near-end Eye Symmetry Mask Width (ESMW)	TP4		0.265		UI	
Near-end Eye Height, Differential	TP4	70			mV	
Far-end Eye Symmetry Mask Width (ESMW)	TP4		0.2		UI	
Far-end Eye Height, Differential	TP4	30			mV	
Far-end Pre-cursor ISI Ratio	TP4	-4.5		2.5	%	
Common Mode Output Voltage (Vcm)	TP4	-350		2850	mV	3

Notes:

1. With the exception to IEEE 802.3bs 120E.3.1.2 that the pattern is PRBS31Q or scrambled idle.
2. Meets BER specified in IEEE 802.3bs 120E.1.1.
3. DC common mode voltage generated by the host. Specification includes effects of ground offset voltage.



CL-QDD-FR4-2
400G QSFP DD Optical Transceiver Module
RoHS 6 compliant

V. Transceiver Block Diagram

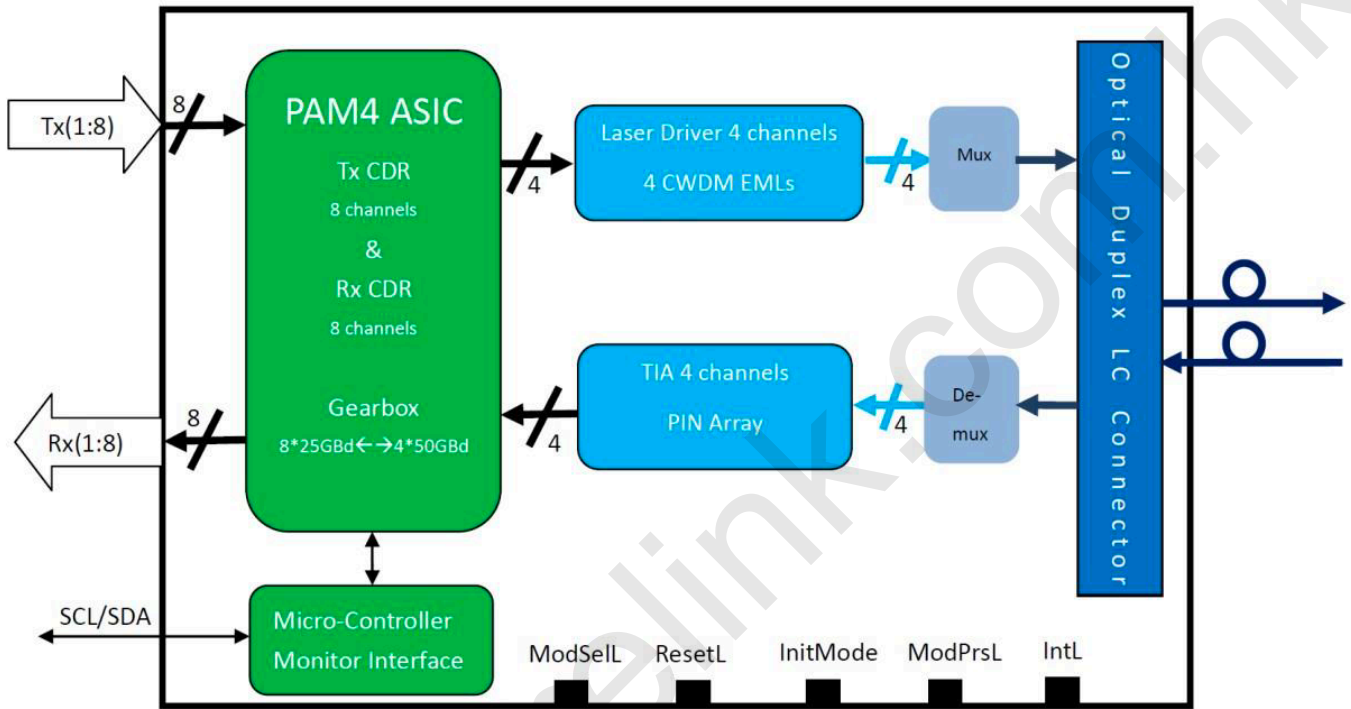



CL-QDD-FR4-2
400G QSFP DD Optical Transceiver Module
RoHS 6 compliant

VI. Pin Diagram

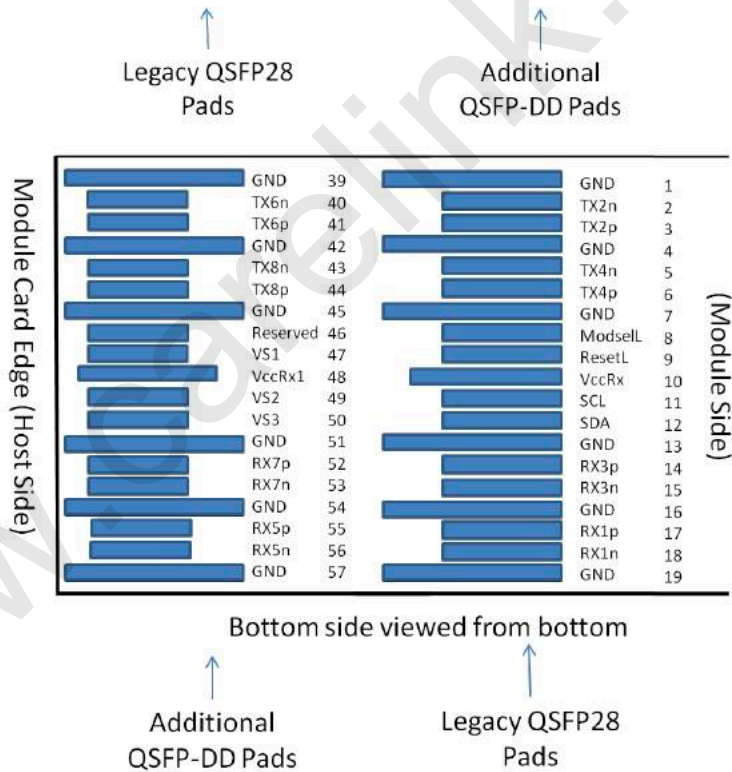
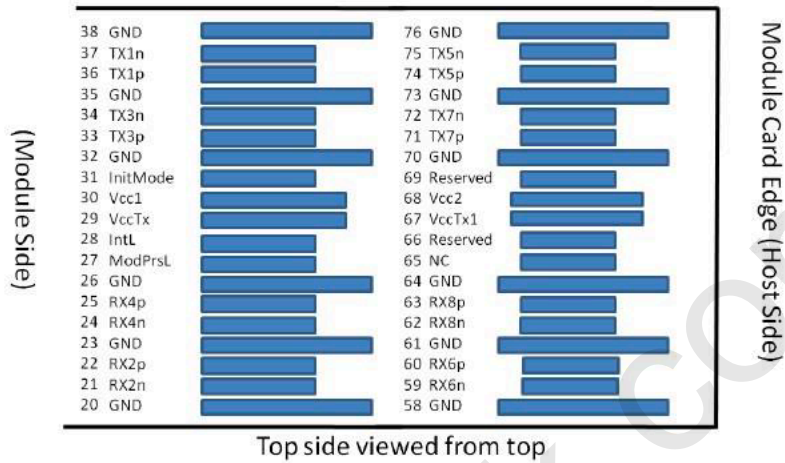



CL-QDD-FR4-2
400G QSFP DD Optical Transceiver Module
RoHS 6 compliant

VII. Pin Descriptions

PIN	Logic	Symbol	Description	Plug Seq.	Notes
1		GND	Ground	1B	
2	CML-I	Tx2n	Transmitter Inverted Data Input	3B	
3	CML-I	Tx2p	Transmitter Non-Inverted Data output	3B	
4		GND	Ground	1B	
5	CML-I	Tx4n	Transmitter Inverted Data Input	3B	
6	CML-I	Tx4p	Transmitter Non-Inverted Data output	3B	
7		GND	Ground	1B	
8	LVTLL-I	ModSelL	Module Select	3B	
9	LVTLL-I	ResetL	Module Reset	3B	
10		VccRx	+ 3.3V Power Supply Receiver	2B	
11	LVC MOS-I/O	SCL	2-Wire Serial Interface Clock	3B	
12	LVC MOS-I/O	SDA	2-Wire Serial Interface Data	3B	
13		GND	Ground	1B	
14	CML-O	Rx3p	Receiver Non-Inverted Data Output	3B	
15	CML-O	Rx3n	Receiver Inverted Data Output	3B	
16		GND	Ground	1B	
17	CML-O	Rx1p	Receiver Non-Inverted Data Output	3B	
18	CML-O	Rx1n	Receiver Inverted Data Output	3B	
19		GND	Ground	1B	
20		GND	Ground	1B	
21	CML-O	Rx2n	Receiver Inverted Data Output	3B	
22	CML-O	Rx2p	Receiver Non-Inverted Data Output	3B	
23		GND	Ground	1B	
24	CML-O	Rx4n	Receiver Inverted Data Output	3B	
25	CML-O	Rx4p	Receiver Non-Inverted Data Output	3B	
26		GND	Ground	1B	
27	LVTTL-O	ModPrsL	Module Present	3B	



CL-QDD-FR4-2
400G QSFP DD Optical Transceiver Module
RoHS 6 compliant

28	LVTTTL-O	IntL/RX_LOS	Interrupt/RX_LOS	3B	
29		VccTx	+3.3 V Power Supply transmitter	2B	
30		Vcc1	+3.3 V Power Supply	2B	
31	LVTTTL-I	LPMMode/Tx_DIS	Low Power Mode/Tx Disable	3B	
32		GND	Ground	1B	
33	CML-I	Tx3p	Transmitter Non-Inverted Data Input	3B	
34	CML-I	Tx3n	Transmitter Inverted Data Input	3B	
35		GND	Ground	1B	
36	CML-I	Tx1p	Transmitter Non-Inverted Data Input	3B	
37	CML-I	Tx1n	Transmitter Inverted Data Input	3B	
38		GND	Ground	1B	
39		GND	Ground	1A	
40	CML-I	Tx6n	Transmitter Inverted Data Input	3A	
41	CML-I	Tx6p	Transmitter Non-Inverted Data Input	3A	
42		GND	Ground	1A	
43	CML-I	Tx8n	Transmitter Inverted Data Input	3A	
44	CML-I	Tx8p	Transmitter Non-Inverted Data Input	3A	
45		GND	Ground	1A	
46		Reserved	For future use	3A	
47		VS1	Module Vendor Specific 1	3A	
48		VccRx1	3.3V Power Supply	2A	
49		VS2	Module Vendor Specific 2	3A	
50		VS3	Module Vendor Specific 3	3A	
51		GND	Ground	1A	
52	CML-O	Rx7p	Receiver Non-Inverted Data Output	3A	
53	CML-O	Rx7n	Receiver Inverted Data Output	3A	
54		GND	Ground	1A	
55	CML-O	Rx5p	Receiver Non-Inverted Data Output	3A	
56	CML-O	Rx5n	Receiver Inverted Data Output	3A	
57		GND	Ground	1A	
58		GND	Ground	1A	
59	CML-O	Rx6n	Receiver Inverted Data Output	3A	
60	CML-O	Rx6p	Receiver Non-Inverted Data Output	3A	
61		GND	Ground	1A	



CL-QDD-FR4-2
400G QSFP DD Optical Transceiver Module
RoHS 6 compliant

62	CML-O	Rx8n	Receiver Inverted Data Output	3A	
63	CML-O	Rx8p	Receiver Non-Inverted Data Output	3A	
64		GND	Ground	1A	
65		NC	No Connect	3A	
66		Reserved	For future use	3A	
67		VccTx1	3.3V Power Supply	2A	
68		Vcc2	3.3V Power Supply	2A	
69		Reserved	For future use	3A	
70		GND	Ground	1A	
71	CML-I	Tx7p	Transmitter Non-Inverted Data Input	3A	
72	CML-I	Tx7n	Transmitter Inverted Data Input	3A	
73		GND	Ground	1A	
74	CML-I	Tx5p	Transmitter Non-Inverted Data Input	3A	
75	CML-I	Tx5n	Transmitter Inverted Data Input	3A	
76		GND	Ground	1A	

VIII. Digital Diagnostics

Parameter	Symbol	Min	Max	Units	Notes
Temperature Monitor Absolute Error	DMI_Temp	-3	3	degC	Over operating temperature range
Supply Voltage Monitor Absolute Error	DMI_VCC	0.1	0.1	V	Over full operating range
Channel RX Power Monitor Absolute Error	DMI_RX_C _h	-2	2	dB	1
Channel Bias Current Monitor	DMI_Ibias _{Ch}	-10%	10%	mA	
Channel TX Power Monitor Absolute Error	DMI_TX_C _h	-2	2	dB	1

Notes:

1. Due to measurement accuracy of different single mode fibers, there could be an additional +/- 1 dB fluctuation, or a +/- 3 dB total accuracy.



CL-QDD-FR4-2
400G QSFP DD Optical Transceiver Module
RoHS 6 compliant

IX. Recommended Power Supply Filter

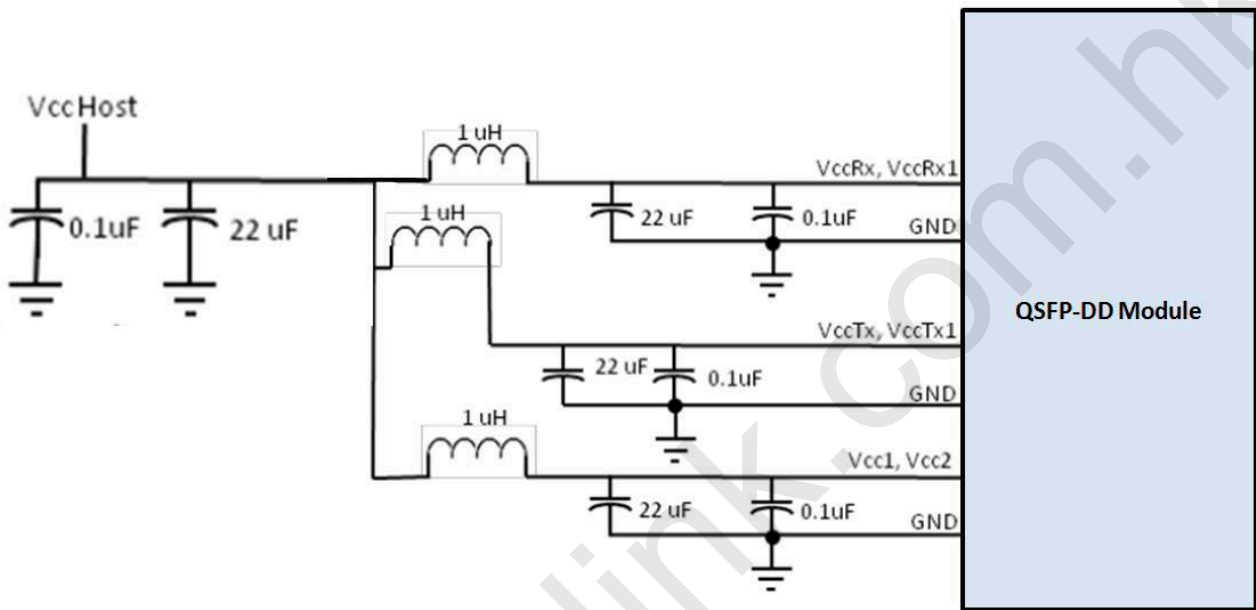

X. Mechanical Specifications(Unit: mm)

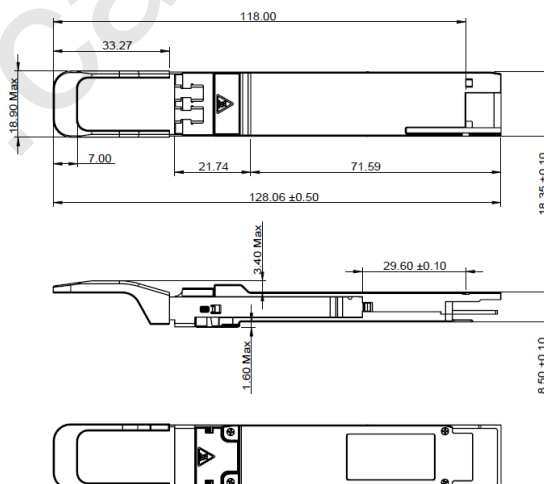

Notice:



CL-QDD-FR4-2
400G QSFP DD Optical Transceiver Module
RoHS 6 compliant

Carelink reserves the right to make changes or discontinue any optical link product or service identified in this publication, without notice, in order to improve design and/or performance.

Applications that are described herein for any of the optical link products are for illustrative purposes only. Carelink makes no representation or warranty that such applications will be suitable for the specified use without further testing or modification.

www.carelink.com.hk