



**RoHS compliant**  
**Small Form Pluggable (SFP+)**  
**SFP+ CWDM 10dB Optical Transceivers**  
**Hot Pluggable, Duplex LC, +3.3V, 1470~1610nm, CWDM DFB, SMF**



### Features

- Supports 8.5to 11.3Gb/s bit rates
- Hot-Pluggable
- Duplex LC connector
- 1470~1610nm CWDM DFB transmitter, PIN photo-detector
- SMF links up to 10dB
- 2-wire interface for management specifications compliant with SFF 8472 digital diagnostic monitoring interface
- Power Supply :+3.3V
- Power consumption<1.5W
- Temperature Range: -5~ 70°C/ -30~ 70°C /-40~ 85°C
- RoHS compliant

### Applications

- 10GBASE-LR/LW Ethernet
- Sonet OC-192/SDH STM-64
- 10G Fibre Channel 1200-SM-LL-L

### Ordering Information

PART NUMBER	TX/RX	INPUT/OUTPUT	SIGNAL DETECT	TEMPERATURE	PACKAGE	Distance
CL-SFP+10CL2-XX		AC/AC	TTL	-5°C to 70 °C	LC SFP +	10db
CL-SFP+10CL2-XXe		AC/AC	TTL	-30°C to 70 °C	LC SFP +	10db
CL-SFP+10CL2-XXi		AC/AC	TTL	-40°C to 85 °C	LC SFP +	10db



RoHS compliant  
 Small Form Pluggable (SFP+)  
 SFP+ CWDM 10dB Optical Transceivers  
 Hot Pluggable, Duplex LC, +3.3V, 1470~1610nm, CWDM DFB, SMF

## Product selection

Carelink' CL-SFP+10CL1-XX is a very compact 10Gb/s optical transceiver module for serial optical communication applications at 10Gb/s. The CL-SFP+10CL2-XX converts a 10Gb/s serial electrical data stream to 10Gb/s optical output signal and a 10Gb/s optical input signal to 10Gb/s serial electrical data streams. The high speed 10Gb/s electrical interface is fully compliant with SFI specification.

The high performance 1470~1610nm CWDM DFB transmitter and high sensitivity PIN receiver provide superior performance for Ethernet applications at up to 10km links.

The SFP+ Module compliant with SFF-8431, SFF-8432 and IEEE 802.3ae 10GBASE-LR. Digital diagnostics functions are available via a 2-wire serial interface, as specified in SFF-8472.

The fully SFP compliant form factor provides hot pluggability, easy optical port upgrades and low EMI emission.

## Absolute Maximum Ratings

Parameter	Symbol	Min.	Typical	Max.	Unit
Storage Temperature	T <sub>s</sub>	-40		+85	°C
Case operating Temperature	T <sub>c</sub>	-5		+70	°C
Supply Voltage	V <sub>CC</sub> T, R	-0.5		4	V
Relative Humidity	RH	0		85	%

## Electrical Characteristics (T<sub>OP</sub>=T<sub>c</sub>, V<sub>CC</sub> = 3.13 to 3.47 Volts)

Parameter	Symbol	Min.	Typical	Max.	Unit	Note
Supply Voltage	V <sub>cc</sub>	3.135		3.465	V	
Supply Current	I <sub>cc</sub>			380	mA	
Power Consumption	P			1.5	W	
<b>Transmitter Section:</b>						
Input differential impedance	R <sub>in</sub>		100		Ω	1
Tx Input Single Ended DC Voltage	V	-0.3		4	V	
Differential input voltage swing	V <sub>in,pp</sub>	180		700	mV	2
Transmit Disable Voltage	VD	2		V <sub>cc</sub>	V	3
Transmit Enable Voltage	VEN	V <sub>ee</sub>		V <sub>ee</sub> +0.8	V	
<b>Receiver Section:</b>						
Single Ended Output Voltage Tolerance	V	-0.3		4	V	
Rx Output Diff Voltage	V <sub>o</sub>	300		850	mV	
Rx Output Rise and Fall Time	Tr/Tf	30			ps	4
LOS Fault	V <sub>LOS fault</sub>	2		V <sub>cc</sub> HOST	V	5
LOS Normal	V <sub>LOS norm</sub>	V <sub>ee</sub>		V <sub>ee</sub> +0.8	V	5

### Note:

1. Connected directly to TX data input pins. AC coupling from pins into laser driver IC.



**RoHS compliant**  
**Small Form Pluggable (SFP+)**  
**SFP+ CWDM 10dB Optical Transceivers**  
**Hot Pluggable, Duplex LC, +3.3V, 1470~1610nm, CWDM DFB, SMF**

2. Per SFF-8431 Rev 3.0
3. Into 100 ohms differential termination.
4. 20%~80%
5. LOS is an open collector output. Should be pulled up with 4.7k –10kΩ on the host board. Normal operation is logic 0; loss of signal is logic 1. Maximum pull-up voltage is 5.5V.

**Optical Parameters(TOP = Tc, VCC = 3.13 to 3.47 Volts)**

Parameter	Symbol	Min	Typ	Max	Unit	Ref.
<b>Transmitter</b>						
Date Rate		8.5	10.3125	11.3	Gb/s	
Optical Wavelength	$\lambda$	$\lambda-6.5$	$\lambda$	$\lambda+6.5$	nm	
Average output power	Po	-4			dBm	1
Optical Extinction Ratio	ER	3.5			dB	1
RMS spectral width	$\Delta\lambda$			1	nm	
Optical Modulation Amplitude	OMA	-5.2			dBm	
Side Mode Suppression Ratio	SMSR	30			dB	
Dispersion penalty				3.2	dB	
Optical Eye Mask		IEEE802.3-2005 Compliant Compliant with ITU-T G.691 and GR-253-CORE				
<b>Receiver</b>						
Date Rate		8.5	10.3125	11.3	Gb/s	
Optical Wavelength	$\lambda$	1470		1610	nm	
Receiver Sensitivity	R			-14	dBm	2
Stressed Receiver Sensitivity	R1			-10.3	dBm	2
Maximum Input Power	PMAX	0.5			dBm	
LOS De-Assert	LOSD			-15	dBm	
LOS Assert	LOSA	-25			dBm	
LOS Hysteresis		0.5		4	dB	
Receiver Reflectance	Rrx			-12	dB	

**Notes:**

- Note 1) Measured at 10.3125Gb/s with PRBS 2<sub>31</sub>-1 NRZ test pattern.  
 Note 2) Under the ER worst case, measured at 10.3125 Gb/s with PRBS 2<sub>31</sub>-1 NRZ test pattern for BER < 1x10<sup>-12</sup>

**Pin Assignment:**



**RoHS compliant**  
**Small Form Pluggable (SFP+)**  
**SFP+ CWDM 10dB Optical Transceivers**  
**Hot Pluggable, Duplex LC, +3.3V, 1470~1610nm, CWDM DFB, SMF**

Diagram of Host Board  
 Connector Block Pin  
 Numbers and Name

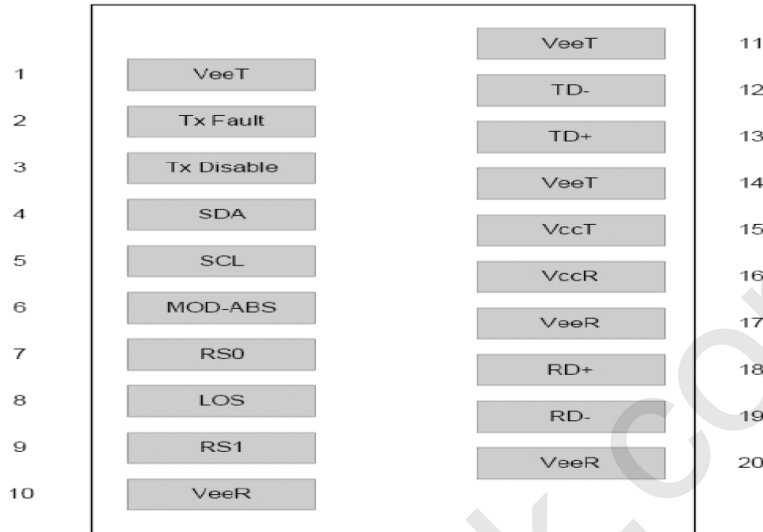

**Pin Function Definitions**

PIN #	Name	Function	Notes
1	VeeT	Module transmitter ground	Note1
2	Tx Fault	Module transmitter fault	Note 2
3	Tx Disable	Transmitter Disable; Turns off transmitter laser output	Note 3
4	SDL	2 wire serial interface data input/output (SDA)	
5	SCL	2 wire serial interface clock input (SCL)	
6	MOD-ABS	Module Absent, connect to VeeR or VeeT in the module	Note 2
7	RS0	Rate select0,optionally control SFP+ receiver. When high, input data rate >4.5Gb/ s;when low, input data rate <=4.5Gb/s	
8	LOS	Receiver Loss of Signal Indication	Note4
9	RS1	Rate select0,optionally control SFP+ transmitter. When high, input data rate >4.5Gb/s;when low, input data rate <=4.5Gb/s	
10	VeeR	Module receiver ground	Note 1
11	VeeR	Module receiver ground	Note 1
12	RD-	Receiver inverted data out put	
13	RD+	Receiver non-inverted data out put	
14	VeeR	Module receiver ground	Note 1
15	VccR	Module receiver 3.3V supply	
16	VccT	Module transmitter 3.3V supply	
17	VeeT	Module transmitter ground	Note 1
18	TD+	Transmitter inverted data out put	
19	TD-	Transmitter non-inverted data out put	
20	VeeT	Module transmitter ground	Note1

Note 1) The module ground pins shall be isolated from the module case.



**RoHS compliant**  
**Small Form Pluggable (SFP+)**  
**SFP+ CWDM 10dB Optical Transceivers**  
**Hot Pluggable, Duplex LC, +3.3V, 1470~1610nm, CWDM DFB, SMF**

Note 2) This pin is an open collector/drain output pin and shall be pulled up with 4.7K-10Kohms to Host\_Vcc on the host board.

Note 3) This pin shall be pulled up with 4.7K-10Kohms to VccT in the module.

Note 4) This pin is an open collector/drain output pin and shall be pulled up with 4.7K

### SFP Module EEPROM Information and Management

The SFP modules implement the 2-wire serial communication protocol as defined in the SFP -8472. The serial ID information of the SFP modules and Digital Diagnostic Monitor parameters can be accessed through the I2C interface at address A0h and A2h. The memory is mapped in Table 1. Detailed ID information(A0h) is listed in Table 2. And the DDM specification at address A2h. For more details of the memory map and byte definitions, please refer to the SFF-8472, “Digital Diagnostic Monitoring Interface for Optical Transceivers”.

**Table 1.**Digital Diagnostic Memory Map (Specific Data Field Descriptions)

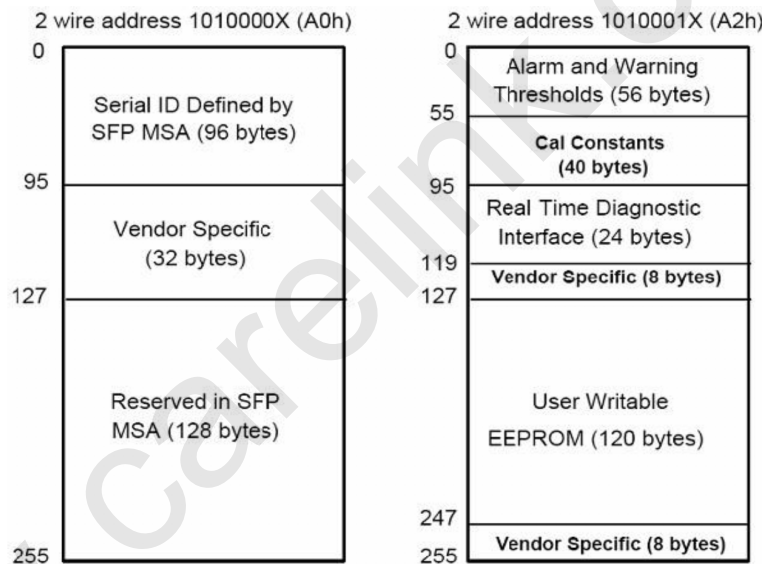

**Table 2 - EEPROM Serial ID Memory Contents (A0h)**

Data Address	Length (Byte)	Name of Length	Description and Contents
Base ID Fields			
0	1	Identifier	Type of Serial transceiver (03h=SFP)
1	1	Reserved	Extended identifier of type serial transceiver (04h)
2	1	Connector	Code of optical connector type (07=LC)
3-10	8	Transceiver	
11	1	Encoding	NRZ(03h)
12	1	BR,Nominal	Nominal baud rate, unit of 100Mbps
13-14	2	Reserved	(0000h)
15	1	Length(9um)	Link length supported for 9/125um fiber, units of 100m
16	1	Length(50um)	Link length supported for 50/125um fiber, units of 10m



**RoHS compliant**  
**Small Form Pluggable (SFP+)**  
**SFP+ CWDM 10dB Optical Transceivers**  
**Hot Pluggable, Duplex LC, +3.3V, 1470~1610nm, CWDM DFB, SMF**

17	1	Length(62.5u	Link length supported for 62.5/125um fiber, units of 10m
18	1	Length(Coppe	Link length supported for copper, units of meters
19	1	Reserved	
20-35	16	Vendor Name	SFP vendor name: Carelink
36	1	Reserved	
37-39	3	Vendor OUI	SFP transceiver vendor OUI ID
40-55	16	Vendor PN	Part Number: "CL-SFP+10CL2-XX" (ASCII)
56-59	4	Vendor rev	Revision level for part number
60-62	3	Reserved	
63	1	CCID	Least significant byte of sum of data in address 0-62
<b>Extended ID Fields</b>			
64-65	2	Option	Indicates which optical SFP signals are implemented (001Ah = LOS, TX_FAULT, TX_DISABLE all supported)
66	1	BR, max	Upper bit rate margin, units of %
67	1	BR, min	Lower bit rate margin, units of %
68-83	16	Vendor SN	Serial number (ASCII)
84-91	8	Date code	Carelink's Manufacturing date code
92-94	3	Reserved	
95	1	CCEX	Check code for the extended ID Fields (addresses 64 to 94)
<b>Vendor Specific ID Fields</b>			
96-127	32	Readable	Carelink specific date, read only
128-255	128	Reserved	Reserved for SFF-8079

## Digital Diagnostic Monitor Characteristics

Data Address	Parameter	Accuracy	Unit
96-97	Transceiver Internal Temperature	±3.0	°C
100-101	Laser Bias Current	±10	%
100-101	Tx Output Power	±3.0	dBm
100-101	Rx Input Power	±3.0	dBm
100-101	VCC3 Internal Supply Voltage	±5.0	%

## Regulatory Compliance

The HXFP-3831MFcomplies with international Electromagnetic Compatibility (EMC) and



**RoHS compliant**  
**Small Form Pluggable (SFP+)**  
**SFP+ CWDM 10dB Optical Transceivers**  
**Hot Pluggable, Duplex LC, +3.3V, 1470~1610nm, CWDM DFB, SMF**

international safety requirements and standards (see details in Table following).

Electrostatic Discharge (ESD) to the Electrical Pins	MIL-STD-883E Method 3015.7	Class 1(>1000 V)
Electrostatic Discharge (ESD) to the Duplex LC Receptacle	IEC 61000-4-2 GR-1089-CORE	Compatible with standards
Electromagnetic Interference (EMI)	FCC Part 15 Class B EN55022 Class B (CISPR 22B) VCCI Class B	Compatible with standards
Laser Eye Safety	FDA 21CFR 1040.10 and 1040.11	Compatible with Class 1 laser product.
	EN60950, EN (IEC) 60825-1,2	

**Recommended Circuit:**

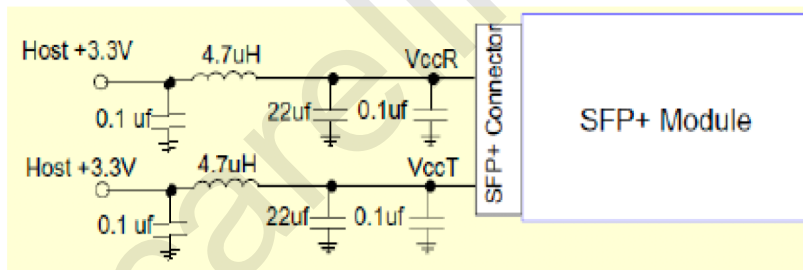

**Recommended Host Board Power Supply Circuit**

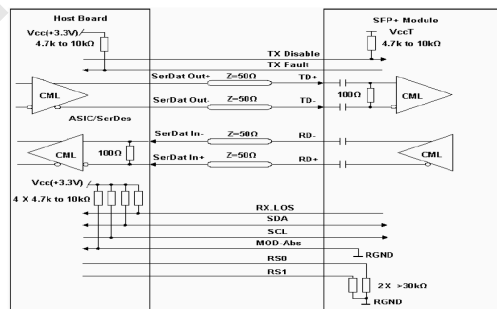

**Recommended High-speed Interface Circuit**

**Mechanical Dimensions:**



**RoHS compliant**  
**Small Form Pluggable (SFP+)**  
**SFP+ CWDM 10dB Optical Transceivers**  
**Hot Pluggable, Duplex LC, +3.3V, 1470~1610nm, CWDM DFB, SMF**

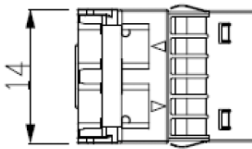
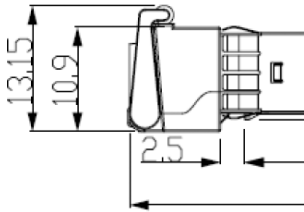
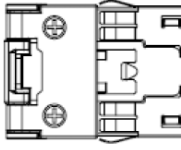

**Notice:**

Carelink reserves the right to make changes or discontinue any optical link product or service identified in this publication, without notice, in order to improve design and/or performance.

Applications that are described herein for any of the optical link products are for illustrative purposes only. Carelink makes no representation or warranty that such applications will be suitable for the specified use without further testing or modification.